



PVC & CPVC Hot-Tap Saddles

HT-2-1112

Allows Connection to Existing Pipelines Under Pressure



Specially designed tapping saddle allows pipe branch connection to pressurized “Hot” lines without system shut-down. Available in PVC White, Gray or CPVC Gray configurations.

- Industrial Grade Bolt-on Saddle with EPDM or FKM O-ring Seals and Choice of Zinc Plated Steel or Type 316 Stainless Steel Hardware.
 - Built-in Brass or Stainless Steel Cutter Easily Cuts Hole in PVC, CPVC, HDPE and PP Pipe. Special Design Captures and Retains Coupon from Hole.
 - Pressure Rated to 235 psi @ 73°F.
- Available to fit IPS Pipe 2" through 8" with Versatile 3/4" Socket - 1" Spigot Combination Branch Outlet or 1"-1/2" Socket - 2" Spigot Combination Branch Outlet

TECHNICAL DATA

Maximum Service Temperatures

PVC 140°F
CPVC 200°F

Note: Elevated service temperatures require system pressure de-rating.

Pressure Rating @ 73°F

2" – 4" 235 psi
6" 200 psi
8" 150 psi

Not for Distribution of Compressed Air or Gas

Some leakage is possible during the tapping process, therefore “hot-taps” are not recommended for corrosive or dangerous fluid medium.

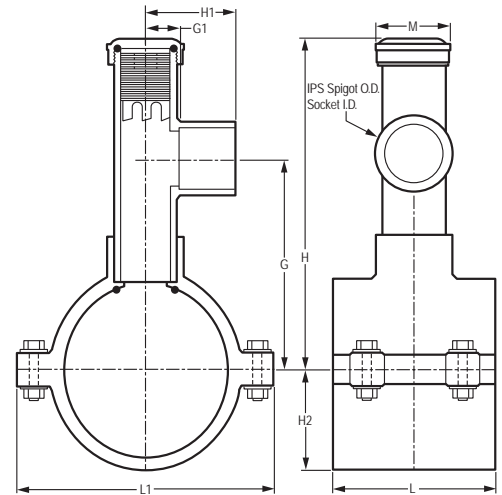

Dimensions - Saddle x Socket (Spigot)

Size	G	G1	H	H 1	H2	L	L1	M
2 x 3/4 (1)	3-9/16	1	6-3/16	2	1-1/2	2-7/16	3-1/2	2
2 x 1-1/2 (2)	4-9/16	1-1/4	8-15/16	2-11/16	1-1/2	2-7/16	3-1/2	2-7/8
2-1/2 x 3/4 (1)	3-15/16	1	6-9/16	2	1-3/4	4-1/8	4-1/8	2
2-1/2 x 1-1/2 (2)	4-13/16	1-1/4	9-3/16	2-11/16	1-3/4	4-1/8	4-1/8	2-7/8
3 x 3/4 (1)	4-1/6	1	6-11/16	2	2	3	4-3/4	2
3 x 1-1/2 (2)	5-1/4	1-1/4	9-5/8	2-11/16	2	4-1/8	4-3/4	2-7/8
4 x 3/4 (1)	4-11/16	1	7-5/16	2	2-5/8	3	5-13/16	2
4 x 1-1/2 (2)	5-13/16	1-1/4	10-3/16	2-11/16	2-5/8	4-1/8	5-13/16	2-7/8
6 x 3/4 (1)	6	1	8-5/8	2	3-7/8	3	8-1/8	2
6 x 1-1/2 (2)	7-1/8	1-1/4	11-1/2	2-11/16	3-7/8	4-1/8	8-1/8	2-7/8
8 x 3/4 (1)	7-1/4	1	9-7/8	2	4-7/8	8-1/2	10-1/8	2
8 x 1-1/2 (2)	8-9/16	1-1/4	12-9/16	2-11/16	4-7/8	8-1/2	10-1/8	2-7/8

Basic Installation

Hot-Tap Saddles are designed for adding branch connections to piping systems under live ("hot") pressure. Hot-Tap Saddle branch outlets are either 3/4" socket (with 1" Spigot O.D.) or 1-1/2" socket (with 2" Spigot O.D.) in saddle sizes 2" through 8" to fit IPS pipe using a built-in O-ring seal. Internal cutter is operated using conventional ratchet and drive extension and permanently retains coupon cut from pipe. Maximum operating pressure at 73°F is 235 psi for saddle sizes 2" - 4", 200 psi for 6" saddles & 150 psi for 8".

SEE PRODUCT INSTALLATION INSTRUCTION FOR DETAILS

COMPONENTS

The Hot-Tap Saddle includes the following components:

1. Cap
2. Upper O-ring
3. Hot-Tap Cutter
4. Bolt/Washer
5. Saddle Body
6. Lower O-ring
7. Saddle Bottom
8. Nut/Washer

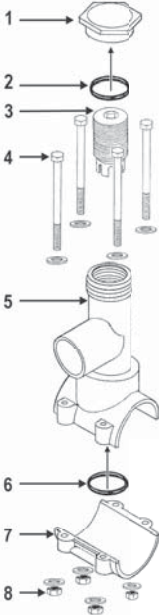

STEP 3 Cement Branch Take-off

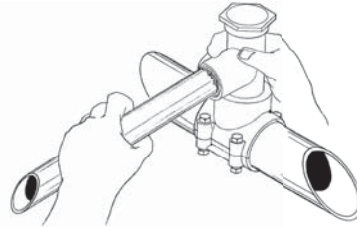

Allow joint to cure.

STEP 4 Remove Cap

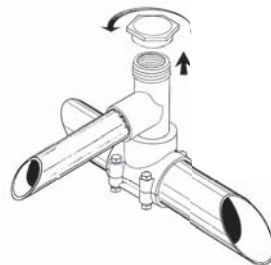

STEP 6 Back-off Cutter to Top to Open Flow

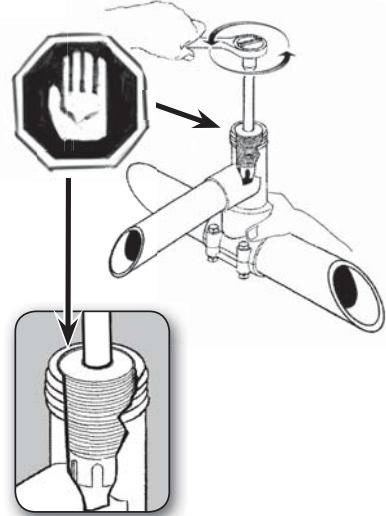

STEP 7 Reinstall Opening Sealed Cap



STEP 1 Assemble on Pipe

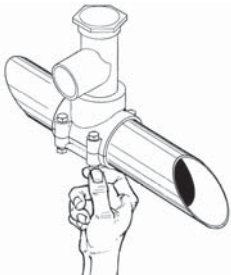

STEP 5 Tap to Required Depth

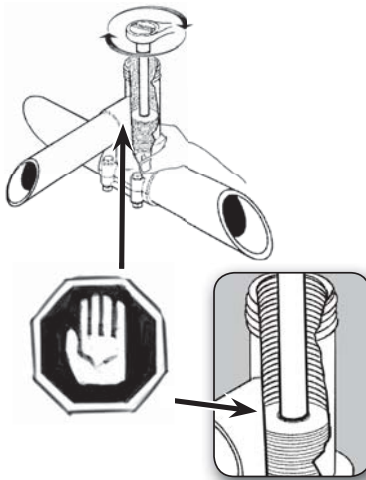

STEP 2 Torque to Specifications

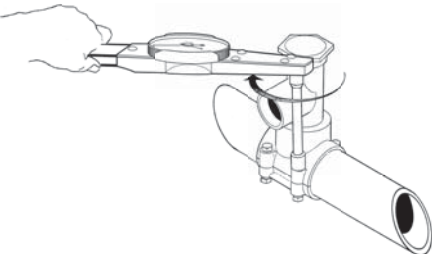

NOT FOR DISTRIBUTION OF COMPRESSED AIR OR GAS.



SPEARS® MANUFACTURING COMPANY
CORPORATE OFFICE

15853 Olden St., Sylmar, CA 91342 • PO Box 9203, Sylmar, CA 91392
(818) 364-1611 • www.spearsmfg.com

